

Name : _____ Form : _____

Year Nine Trench Warfare
SATs Revision

The First World War lasted four years from 1914 - 1918. There were many long term causes however it was the assassination of the Arch Duke Franz Ferdinand (the heir to the Austro - Hungarian throne) in June 1914 that sparked the outbreak of war. Europe had been split in two with countries making allies (agree to fight together) incase there was a war.

Triple Alliance	Triple Entente
Germany	Britain
Austria - Hungary	France
Italy	Russia



The British used **propaganda** posters to try and persuade men in Britain to join the army. The poster shows Lord Kitchener saying the famous phrase "your country needs you." However, by 1916 the number of men volunteering to join the army dropped so the government introduced **conscription**. Men between the ages 14 - 41 were forced by law to serve in the armed forces. Many men were being killed on the Western front and many men had lost their enthusiasm for joining the army and fighting in the war. The men who refused to join the army and fight in the war were called **conscientious**

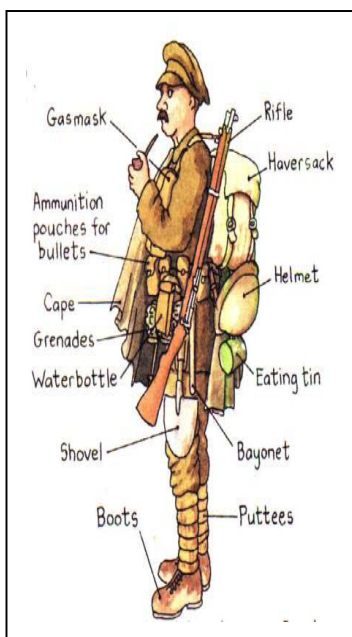

objectors. By 1917 the Russians left the war because there was a communist revolution and the Americans had joined on the same side of Britain and France. By 1917 the Russians left the war because there was a communist revolution and the Americans had joined on the same side of Britain and France.

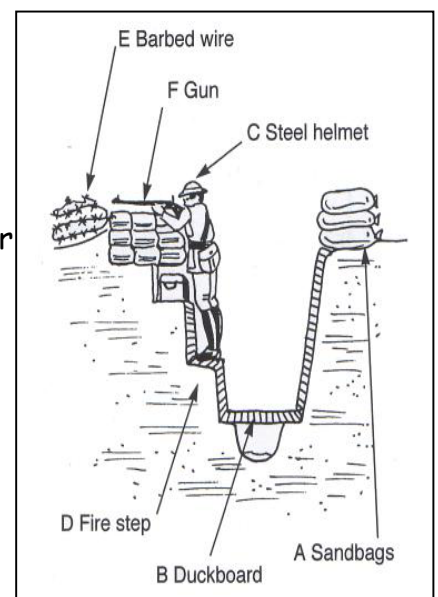





A. Sandbags	Supported the sides of the trench.
B. Duckboard	Stopped the bottom of the trench getting very muddy and slippy.
C. Steel helmet	Protect the soldiers from shrapnel and bullets.
D. Fire helmet	To shoot from.
E. Barbed wire	To stop the enemy entering the trench.
F. Gun	To defend your position from attack.

To relieve the boredom soldiers wrote letters home. However, these were censored to stop the people back in Britain from getting discouraged. When soldiers attacked the enemy's trench they went 'over the top'. This meant climbing out of your front line trench and going across no mans land to attack the enemy. Many soldiers however didn't make it across because they were killed by machine gun fire. The machine gun was the main weapon of the First World War. They had the power of 100 rifles and could be operated by a single soldier. They could fire over 500 bullets a minute. Most of the fighting took place on the Western front. This was a line of trenches on the borders of two countries, France and Belgium. The war ended with the Allies (Britain, France, America) winning. The Treaty of Versailles was signed by Germany in 1919. In this it accepted all responsibility for starting the war.

Circle the correct answer below.

1. What was it called when a soldier goes mad because of the sound of shells?	Senile dementia	Shell shock	Shell madness
2. What was it called when a soldier leaves the trenches and runs towards the enemy to attack?	Going through	Going over the top	Going to attack
3. What was the space between the enemy trenches called?	No-mans's land	Unmarked territory	minefield
4. Where did the main fighting during WW1 take place?	In the air	At sea	In the trenches
5. Which of these weapons wasn't used in WW1?	gas	Atom bomb	Flame thrower
6. What is another word for the big guns used during WW1?	bombardment	attack	artillery

	Shell fire	The real test was the barrage. The noise from the shells would make some soldiers go mad. This was called shell shock.
	Gas	Chlorine gas caused a slow and painful death. Men's lips frothed and they were sick. Mustard gas ripped open men's lungs. Soldiers had to carry their gas masks at all times in the trenches.
	Trench foot	Men stood for many hours on end in waterlogged trenches without being able to remove wet socks or boots. The feet would go numb and the skin would turn red or blue. If not treated the foot would turn gang green and have to be amputated.
	Snipers	There was a constant danger from snipers. If your head popped above the trench you in danger of being shot by a German sniper.
	Rations	Soldiers were always hungry. For breakfast one slice of bread without butter or jam and hard biscuits for tea. Sometimes when drinking water didn't arrive soldiers had to boil water taken from shell holes.
	Disease	Soldiers would catch many diseases in the trenches due to the poor living conditions. They could catch Pneumonia, fever, meningitis as well as being shot at and bombarded by the enemies shells.
	Weather	Constant rain and snow would turn the earth into mud. Trenches would flood and fall apart and there was no protection in the trenches from the weather for the soldiers.
	Routine	Life in the trenches was boring. Trench maintenance went on all the time a job without end. Then there was weapon cleaning and inspection. Every morning after breakfast the commanding officer would give out duties for the day.
	Body Lice	The soldiers had no washing facilities. The soldiers caught lice and this caused a high fever and severe itching.

Life in the trenches

